



TELEDYNE
OLDHAM SIMTRONICS
Everywhereyoulook™

OLCT 20

GAS DETECTOR



User Manuals in other languages are available on
Website <https://teledynegasandflamedetection.com>



Copyright © February 2024 by TELEDYNE OLDHAM SIMTRONICS S.A.S.

All rights reserved. No reproduction of all or part of this document, in any form, is permitted without the written consent of TELEDYNE OLDHAM SIMTRONICS S.A.S.

All of the information that is provided in this document is accurate to the best of our knowledge.

As a result of continuous research and development, the specifications of this product may be changed without prior notice.

TELEDYNE OLDHAM SIMTRONICS S.A.S.

Rue Orfila

Z.I. Est – CS 20417

62027 ARRAS Cedex

Table of Contents

1	Overview	1
1.1	Limitation of Liability	1
1.2	Ownership clauses	1
1.3	Warnings.....	2
1.4	Warranty.....	2
1.5	Important Information	2
1.6	Destruction of equipment.....	3
1.7	Symbols used.....	3
2	Description	5
2.1	Overview.....	5
2.2	Main characteristics of the various versions	5
2.3	Mechanical installation of the various versions.....	6
3	Wiring Arrangements	7
3.1	3-wire version (OLC 20d, OLCT 20d).....	7
3.2	2-wire version (OLCT 20d).....	7
3.3	2-wire Intrinsic Safety version (OLCT 20i).....	8
4	Installation	9
4.1	Regulations and operating conditions	9
4.2	Positioning the detector	9
4.3	Mounting the detector.....	10
5	Maintenance	11
5.1	Maintenance frequency	11
5.2	Detector OLC 20.....	12
5.3	Transmitters OLCT 20.....	12
5.4	Replacing a sensor on OLCT 20.....	14
6	Spare Parts	15



6.1	Flameproof approved replacement sensors	15
6.2	Intrinsically-safe approved replacement sensors.....	16
7	Accessories	17
8	Technical Specifications.....	19
8.1	Common.....	19
8.2	OLC 20d	19
8.3	OLCT 20d.....	19
8.4	OLCT 20i.....	19
8.5	Sensors	20
8.6	Cross gas factors for combustible gases.....	22
9	Special instructions for use in explosive atmospheres and functional safety	25
9.1	General comments	25
9.2	Warnings.....	25
9.3	Requirements for use in dust explosive atmospheres	25
9.4	Cable entries.....	25
9.5	Threaded joints	26
9.6	Limitations of use.....	26
9.7	Overrange and exposition to specific components	26
9.8	Operation under low oxygen levels.....	26
9.9	Installation and calibration.....	27
9.10	Marking.....	27

1 Overview

Thank you for choosing this TELEDYNE OLDHAM SIMTRONICS instrument.

All necessary actions have been taken to ensure your complete satisfaction with this equipment.

It is important that you read this entire manual carefully and thoroughly.

1.1 Limitation of Liability

- TELEDYNE OLDHAM SIMTRONICS shall not be held responsible for any damage to the equipment or for any physical injury or death resulting in whole or in part from the inappropriate use or installation of the equipment, non-compliance with any and all instructions, warnings, standards and/or regulations in force.
- No business, person or legal entity may assume responsibility on behalf of TELEDYNE OLDHAM SIMTRONICS, even though they may be involved in the sale of TELEDYNE OLDHAM SIMTRONICS products.
- TELEDYNE OLDHAM SIMTRONICS shall not be responsible for any direct or indirect damage, or any direct or indirect consequence, resulting from the sale and use of any of its products **UNLESS SUCH PRODUCTS HAVE BEEN SELECTED BY TELEDYNE OLDHAM SIMTRONICS ACCORDING TO THE APPLICATION.**

1.2 Ownership clauses

- The drawings, specifications, and information herein contain confidential information that is the property of TELEDYNE OLDHAM SIMTRONICS.
- This information shall not, either in whole or in part, by physical, electronic, or any other means whatsoever, be reproduced, copied, divulged, translated, or used as the basis for the manufacture or sale of TELEDYNE OLDHAM SIMTRONICS equipment, or for any other reason **without the prior written consent of TELEDYNE OLDHAM SIMTRONICS.**

1.3 Warnings

- This is not a contractual document. TELEDYNE OLDHAM SIMTRONICS reserves the right to alter the technical features of its equipment at any time and for any reason without prior notice.
- READ THESE INSTRUCTIONS CAREFULLY BEFORE USING FOR THE FIRST TIME: these instructions should be read by all persons who have or will have responsibility for the use, maintenance, or repair of the instrument.
- This instrument shall only be deemed to be in conformance with the published performance if used, maintained, and repaired in accordance with the instructions of TELEDYNE OLDHAM SIMTRONICS, by TELEDYNE OLDHAM SIMTRONICS personnel, or by personnel authorized by TELEDYNE OLDHAM SIMTRONICS.

1.4 Warranty

Under normal conditions of use and on return to the factory, parts and workmanship are guaranteed for 2 years, excluding consumables such as sensors, filters, etc.

1.5 Important Information

The modification of the material and the use of parts of an unspecified origin shall entail the cancellation of any form of warranty.

The use of the unit has been projected for the applications specified in the technical characteristics. Exceeding the indicated values cannot in any case be authorized.

Catalytic sensors are susceptible to poisoning by traces of several substances. This leads to an inhibition which can be permanent or temporary depending on the contaminant, the concentration of the contaminant, the duration of exposure to the contaminant.

Poisoning may result from exposure to substances as:

- silicones (e.g. waterproofing, adhesives, release agents, special oils and greases, certain medical products, commercial cleaning agents)
- tetraethyl lead (e.g. leaded petrol, particularly aviation petrol 'Avgas')
- sulfur compounds (sulfur dioxide, hydrogen sulfide)
- halogenated compounds (R134a, HFO, etc.)
- organo-phosphorus compounds (e.g. herbicides, insecticides, and phosphate esters in fireproof hydraulic fluids)

TELEDYNE OLDHAM SIMTRONICS recommends regular testing of fixed gas detection installations.





1.6 Destruction of equipment



European Union only. This symbol indicates that, in conformity with directive DEEE (2002/96/CE) and in accordance with local regulations, this product must not be discarded with household waste.

It must be disposed of in a collection area that is designated for this purpose, for example at a site that is officially designated for recycling of electrical and electronic equipment (EEE) or a point of exchange for authorized products in the event of the acquisition of a new product of the same type.

1.7 Symbols used

Icon	Signification
	This symbol indicates: useful additional information.
	This symbol indicates: This equipment must be connected to ground.
	This symbol denotes: Protective earth terminal. A cable of the adequate diameter must be connected to ground and to the terminal having this symbol
	This symbol denotes: Warning! In the present mode of use, failure to adhere to the instructions preceded by this symbol can result in a risk of electric shock and/or death.
	This symbol indicates: You must refer to the instructions.



2 Description

2.1 Overview

OLC 20 gas detectors are catalytic type detectors intended for the detection of combustible gases. They are flameproof certified (OLC 20d).

OLCT 20 gas detectors are 4-20 mA transmitters and are intended for the measurement of combustible and toxic gases and oxygen. They are either flameproof certified (OLCT 20d) or intrinsically safe certified (OLCT 20i).

OLC 20s and OLCT 20s are available in ¾ NPT or M25 screw fittings and are designed to be attached on a junction box or any compatible generic transmitters.

OLC20D and OLCT20D (D signifies remote version) are intended to be mounted in place by means of a bracket supplied as an accessory. Also supplied with 15-meter length of shielded cable which can be connected to the measurement controller either directly or via a junction box if the cable length is greater.

2.2 Main characteristics of the various versions

	OLC 20	OLCT 20	
		OLCT 20D	
	LEL	LEL	TOX/O ₂
Flameproof design	✓	✓	✓
Intrinsic safety design			✓
3-wire cable / Wheatstone bridge	✓		
3-wire cable / 4-20 mA output		✓	
2-wire cable / 4-20 mA output			✓
Catalytic sensor	✓	✓	
Electrochemical sensor			✓
Replacement catalytic sensor	✓		
Replacement pre-calibrated sensor		✓	✓



2.3 Mechanical installation of the various versions

Please ensure you read the paragraph: Special Specifications for use in Potentially Explosive Atmospheres in Accordance with European Directive ATEX 2014/34/EU.

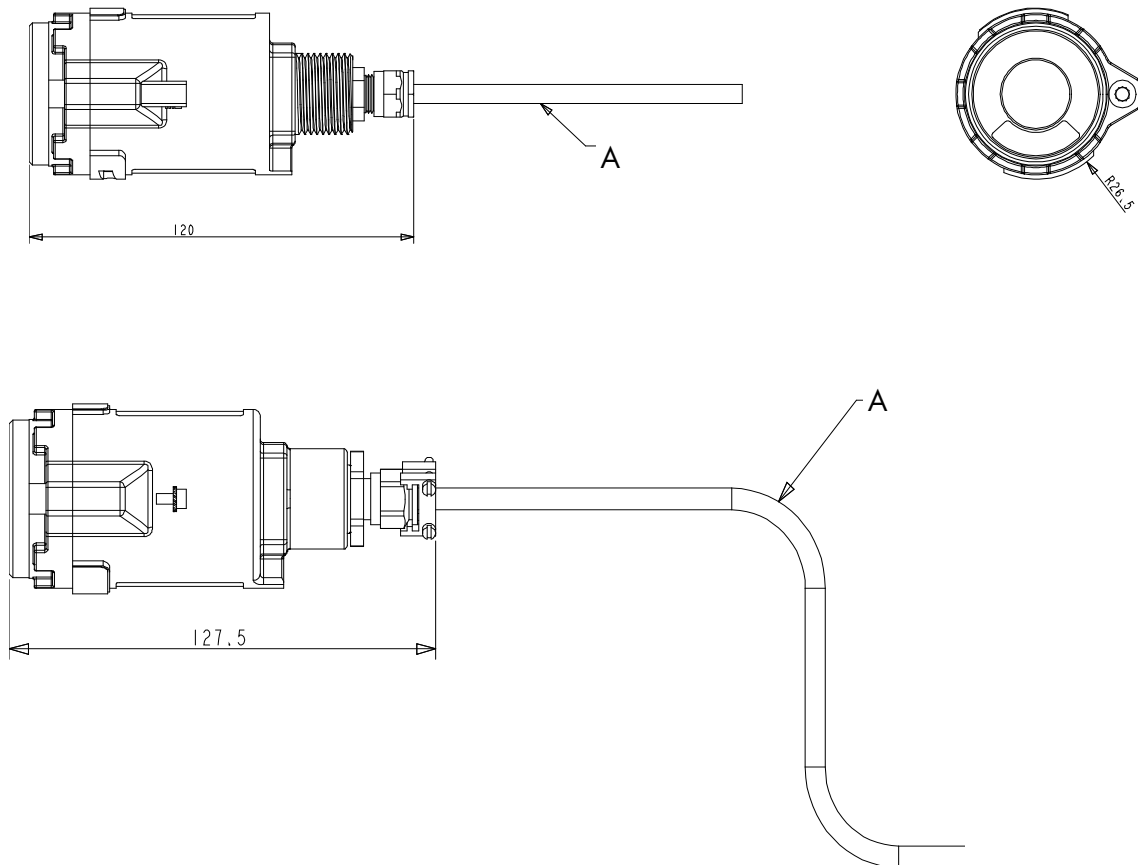

Figure 1 : Dimensions

Cable length	A
OLC/OLCT 20	0.2 m
OLCT20D	15m

3 Wiring Arrangements

Please ensure you read the paragraph: Special Specifications for use in Explosive Atmospheres in Accordance with European Directive ATEX 2014/34/EU.

3.1 3-wire version (OLC 20d, OLCT 20d)

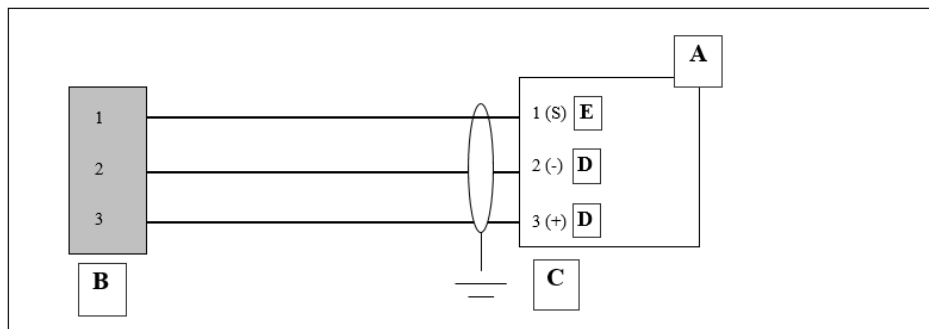

Figure 2

A	B	C	D	E
TELEDYNE OLDHAM SIMTRONICS controller	OLC or OLCT 20	Grounding	Power supply	Signal (I)

3.2 2-wire version (OLCT 20d)

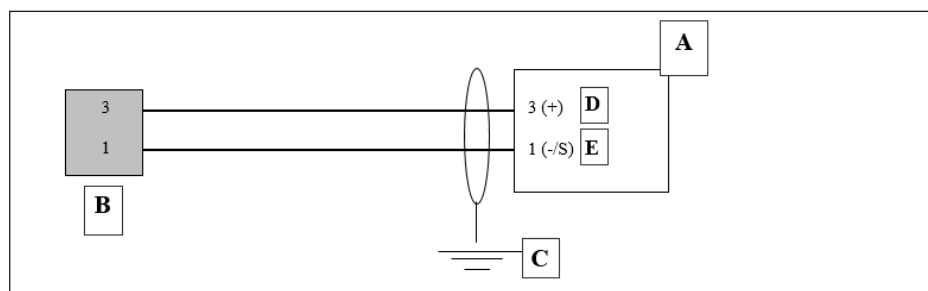

Figure 3

A	B	C	D	E
TELEDYNE OLDHAM SIMTRONICS controller	OLCT 20	Grounding	Power supply	Signal (I)



3.3 2-wire Intrinsic Safety version (OLCT 20i)

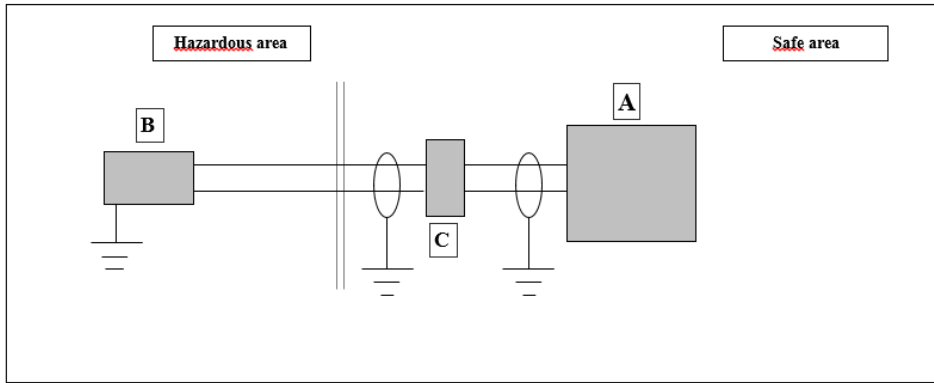

Figure 4

A	B	C
TELEDYNE OLDHAM SIMTRONICS controller	OLCT 20	Zener Barrier

4 Installation



It is recommended that you read the relevant guides for installing, operating and maintaining flammable gas and oxygen detectors (EN 60079-29-2) and toxic detectors (EN 45544-4).

4.1 Regulations and operating conditions

- Installation must comply with current edition of EN 60079-14 for systems installed in explosive atmospheres and eventually with any local or national additional requirements that may apply in the country of installation.



Remote versions of the OLCT20 are supplied with cables that comply with temperature requirements.

However, depending of the risks analysis of the installation under consideration, adequate protection must be provided in accordance with IEC 60079-14 (including paragraph 9.3.7).

- In general, the ambient temperature, the power supply voltage and power mentioned in this document pertain to safety precautions against explosion. These temperatures are not the detector's operating temperatures.
- OLC20d and OLCT20d are authorized for use in zones 1, 2, 21 and 22 for ambient temperatures ranging between -20°C to +70°C (except OLC20d HT. See chapter 9).
- OLCT20i are authorized for use in zones 0, 1, 2, 20, 21 and 22 for ambient temperatures ranging between -20°C to +70°C.
- The detection sensor must always be in contact with the ambient air. Therefore:
 - Do not cover the detection module.
 - Do not apply paint on the detection module.
 - Keep dust from building up.

4.2 Positioning the detector

The detector should be positioned at ground level, on the ceiling, at the height of the respiratory tract or near air extraction ducts, depending on the application or the density of the gas to be detected. Heavy gases should be detected at ground level, while light gases should be detected at ceiling height.

4.3 Mounting the detector

The detector must be installed with the detection sensor pointing downwards. For combustible gas detectors, tilting the device more than 45° past vertical can lead to imprecise readings.

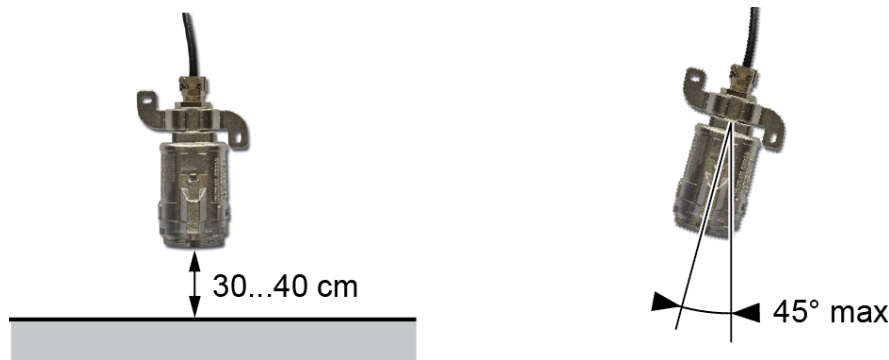

Despite its high degree of protection (IP66), it may be necessary to protect the detector against adverse weather conditions (rain, dust, direct sunlight, etc.) and from direct spraying with cleaning or maintenance products (causing soiling of the detection sensor).

The detector must also be positioned so as to allow access to the measuring sensor so that it can be replaced easily.

Factors to be considered in determining optimal detector positioning:

- potential sources of gas and vapour emissions
- chemical and physical data on gases and vapours which may be present
- liquids with low volatility (place the detectors as near as possible to the leak)
- type and concentration of gas leaks (high-pressure jet, slow leak, etc.)
- air movements:
 - indoors: natural and mechanical ventilation
 - outdoors: wind speed and direction
- effect of temperature
- installation so as to avoid mechanical damage or deterioration caused by water in summer
- positioning to allow easy maintenance, if possible
- avoiding direct sunlight on the readout area as this would lead to maintenance problems

5 Maintenance



The operations explained in this section must be performed by authorized, qualified personnel because they could affect detection reliability. Inspection and maintenance must be carried out in accordance with the current editions of EN60079-17 and eventually with any local or national additional requirements that may apply in the country of installation.

It is prohibited to open the transmitter when energized

Periodic inspections ensure that the equipment and system is functioning properly and providing reliable detection services. The section describes the preventative maintenance procedures required and how often they are to be performed. Inspection and maintenance must be carried out in accordance with the current editions of EN60079-17 and eventually with any local or national additional requirements that may apply in the country of installation.

5.1 Maintenance frequency

Gas detectors are safety devices. TELEDYNE OLDHAM SIMTRONICS recommends regular testing of fixed gas detection installations. This type of test involves injecting a standard gas of sufficient concentration into the detector to trigger pre-set alarms. This test does not, in any event, replace a full calibration of the detector.

Frequency of gas testing depends on the industrial application in which the detector is used. Inspection should occur frequently during the months following installation start-up; later it may be spaced out if no significant problem is observed. If a detector does not react upon contact with gas, it must be calibrated. Calibration frequency will depend on the results of these tests (moisture, temperature, dust, etc.); however, the device should be calibrated at least once per year.

The site manager is responsible for implementing the safety procedures at the site. TELEDYNE OLDHAM SIMTRONICS is not responsible for implementing safety procedures.



5.2 Detector OLC 20

5.2.1 Calibration

On the controller	On the detector
<p>Set the measuring channel to the calibration position (alarm relays inhibited)</p> <p style="text-align: right;">└─┬─▶</p> <p>Proceed the zero and span</p> <p style="text-align: center;">↓</p> <p>Set the measuring channel back to the "normal" position and make sure that it is working properly.</p>	<div style="text-align: center;">  </div> <p>Apply the calibration cup and perform the calibration in accordance with the procedure defined during the training course provided by TELEDYNE OLDHAM SIMTRONICS or by an TELEDYNE OLDHAM SIMTRONICS's authorized person</p> <p style="text-align: left;">←┬─┘</p>

5.2.2 Replacing a sensor on an OLC 20

When?

- When the sensor is damaged or cannot be calibrated
- On a preventive basis

How?

- Turn off the relevant measuring channel
- Remove the sensor to be replaced
- Replace it with a new sensor
- Turn on the channel and check that it operates correctly

5.3 Transmitters OLCT 20

OLCT 20 gas transmitters are equipped with a pre-calibrated sensor and do not require any adjustment on installation.

However, as gas detectors are safety equipment, it is recommended to bump test the complete transmitter after a sensor replacement.

5.3.1 Calibration

After removing the sensor from the transmitter, perform the calibration by using the calibrating bench provided for that purpose (see CALIBRO's user manual).

Procedure

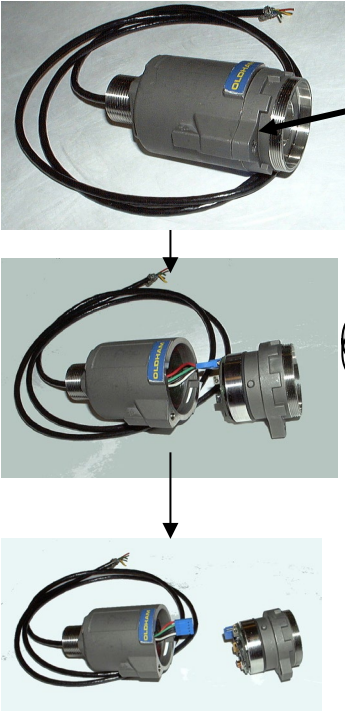
On the controller	On the detector
<p>Set the measuring channel to the calibration position (alarm relays inhibited)</p> <p>Set the measuring channel back to the "normal" position and make sure that it is working properly.</p>	 <p>Loosen the locking screw</p> <p>1 Rotate the sensor module and extract it</p> <p>2</p> <p>Once calibrated put the sensor back in place or use a replacement sensor and reinstall the whole assembly.</p>

5.3.2 Calibration specifications



Calibration shall be performed **outside classified areas** and by using **suitable equipment** that is described during the training course provided by TELEDYNE OLDHAM SIMTRONICS or by a person authorized by TELEDYNE OLDHAM SIMTRONICS.

OLCT 20 sensor module
(LEL/TOX/O₂)

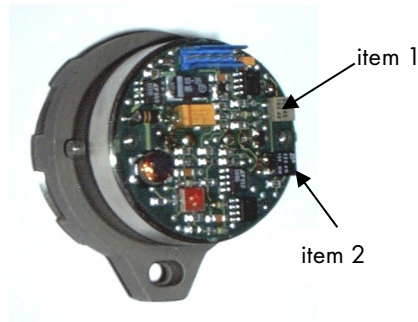

- Adjustment of 0 in clean air, using potentiometer (item 1).
- Adjustment of sensitivity (with standard gas), using the potentiometer (item 2).

5.4 Replacing a sensor on OLCT 20

When?

- When the sensor is damaged or cannot be calibrated.
- On a preventive basis.

How?

- Turn off the relevant measuring channel.
- Remove the sensor to be replaced.
- Replace it with a new, precalibrated unit.
- Turn the channel on and check that it operates correctly.

6 Spare Parts



All replacement parts must be TELEDYNE OLDHAM SIMTRONICS-manufactured parts. The use of non-TELEDYNE OLDHAM SIMTRONICS parts could jeopardize the instrument's safety.

6.1 Flameproof approved replacement sensors

Part number	Description
6 313 757	OLC 20d sensor cell, 0-100% LEL, VQ1 type
6 313 758	OLC 20d sensor cell, 0-100% LEL, 4F type
6 313 995	OLC20d sensor cell, 0--100% LEL, butadiene/acetylene, VQ1 type
6 313 759	OLC20d sensor cell, 0-100% vol. CH ₄
6 314 204	OLC 20d sensor cell, 0-100% vol. H ₂
6 313 988	OLC 20d sensor cell, 0-100% vol. SF ₆
6 313 689	OLC 20d HT sensor cell, 0-100% LEL, VQ1 type
6 313 685-xxx	OLCT 20d sensor cell, 0-100% LEL, VQ1 type
6 313 974-xxx	OLCT 20d poison control sensor cell, 0-100% LEL, 4F type
6 313 872	OLCT 20d sensor cell, 0-100% LEL, butadiene/acetylene, VQ1 type
6 313 687	OLCT 20d sensor cell, 0-100% vol. CH ₄
6 313 986	OLCT 20d sensor cell, 0-100% vol. SF ₆
6 313 203	OLCT 20d sensor cell, 0-100% vol. H ₂
6 314 100	Infrared sensor cell, 0-5% vol. CO ₂ , for OLCT 20 XP IR
6 314 101	Infrared sensor cell, 0-10% vol. CO ₂ , for OLCT 20 XP IR
6 314 146	Infrared sensor cell, 0-100% vol. CO ₂ , for OLCT 20 XP IR
6 313 710	OLCT 20d O ₂ sensor cell, 0-30% vol.
6 313 707	OLCT 20d NH ₃ sensor cell, 0-100 ppm
6 313 708	OLCT 20d NH ₃ sensor cell, 0-1000 ppm
6 313 894	OLCT 20d NH ₃ sensor cell, 0-5000 ppm
6 313 690	OLCT 20d CO sensor cell, 0-100 ppm
6 313 691	OLCT 20d CO sensor cell, 0-300 ppm
6 313 692	OLCT 20d CO sensor cell, 0-1000 ppm
6 313 693	OLCT 20d CO (H ₂ null) sensor cell, 0-1000 ppm
6 313 695	OLCT 20d H ₂ S sensor cell, 0-30 ppm
6 313 965	OLCT 20d H ₂ S sensor cell, 0-30 ppm, no HC interference
6 313 696	OLCT 20d H ₂ S sensor cell, 0-100 ppm
6 313 697	OLCT 20d H ₂ S sensor cell, 0-1000 ppm
6 313 698	OLCT 20d sensor cell, 0-100 ppm NO
6 313 699	OLCT 20d sensor cell, 0-300 ppm NO
6 313 700	OLCT 20d sensor cell, 0-1000 ppm NO
6 313 706	OLCT 20d sensor cell, 0-2000 ppm H ₂







Part number	Description
6 313 772	OLCT 20d sensor cell, methylene/methylene chloride
6 313 773	OLCT 20d sensor cell, R12
6 313 774	OLCT 20d sensor cell, R134a
6 313 775	OLCT 20d sensor cell, MOS

xxx number from 001 to 099 corresponding to gas code

6.2 Intrinsically-safe approved replacement sensors

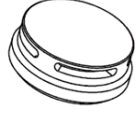

Part number	Description
6 313 748	OLCT 20i O ₂ sensor cell, 0 - 30% vol.
6 313 728	OLCT 20i NH ₃ sensor cell, 0-100 ppm
6 313 729	OLCT 20i NH ₃ sensor cell, 0-1000 ppm
6 313 895	OLCT 20i NH ₃ sensor cell, 0-5000 ppm
6 313 694	OLCT 20i CO (H ₂ null) sensor cell, 0-1000 ppm
6 313 711	OLCT 20i CO sensor cell, 0-100 ppm
6 313 712	OLCT 20i CO sensor cell, 0-300 ppm
6 313 713	OLCT 20i CO sensor cell, 0-1000 ppm
6 313 716	OLCT 20i H ₂ S sensor cell, 0-30 ppm
6 313 717	OLCT 20i H ₂ S sensor cell, 0-100 ppm
6 313 718	OLCT 20i H ₂ S sensor cell, 0-1000 ppm
6 313 719	OLCT 20i NO sensor cell, 0-100 ppm
6 313 720	OLCT 20i NO sensor cell, 0-300 ppm
6 313 721	OLCT 20i NO sensor cell, 0-1000 ppm
6 313 722	OLCT 20i NO ₂ sensor cell, 0-10 ppm
6 313 723	OLCT 20i NO ₂ sensor cell, 0-30 ppm
6 313 727	OLCT 20i H ₂ sensor cell, 0-2000 ppm
6 313 730	OLCT 20i HCl sensor cell, 0-30 ppm
6 313 731	OLCT 20i HCl sensor cell, 0-100 ppm
6 313 724	OLCT 20i SO ₂ sensor cell, 0-10 ppm
6 313 725	OLCT 20i SO ₂ sensor cell, 0-30 ppm
6 313 726	OLCT 20i SO ₂ sensor cell, 0-100 ppm
6 313 734	OLCT 20i Cl ₂ sensor cell, 0-10 ppm
6 313 746	OLCT 20i ETO sensor cell, 0-50 ppm
6 313 732	OLCT 20i HCN sensor cell, 0-10 ppm
6 313 733	OLCT 20i HCN sensor cell, 0-30 ppm
6 313 736	OLCT 20i COCl ₂ sensor cell, 0-1 ppm
6 313 740	OLCT 20i ClO ₂ sensor cell, 0-3 ppm
6 313 735	OLCT 20i O ₃ sensor cell, 0-1 ppm
6 313 737	OLCT 20i PH ₃ sensor cell, 0-1 ppm
6 313 739	OLCT 20i HF sensor cell, 0-10 ppm
6 313 738	OLCT 20i AsH ₃ sensor cell, 0-1 ppm
6 313 747	OLCT 20i SiH ₄ sensor cell, 0-50 ppm

7 Accessories

Accessory	Use	Illustration	Code
Tool kit	Tool kit for maintenance.		6147869
Gas injection pipe	Inject the calibration gas onto the measurement sensor. Impact on reading: measurement similar to measurement in diffusion mode. Impact on response time: none.		6331141 ⚠ Plastic material. Risk of electrostatic charges. Wipe with a damp cloth
Gas flow head	Used to take bypass readings. Impact on reading: none if calibration is performed under the same conditions (pipe, flow rate). Impact on response time: none.		6327910 ⚠ Plastic material. Risk of electrostatic charges. Wipe with a damp cloth
Splash guard	Protects the detector from liquids. Impact on reading: none. Impact on response time: response time in diffusion mode may increase for certain gases; contact us for more information.		6329004 ⚠ Plastic material. Risk of electrostatic charges. Wipe with a damp cloth
Splash guard in Stainless Steel	Protects the detector from liquids. Impact on reading: none. Impact on response time: response time in diffusion mode may increase for certain gases; contact us for more information.		6129010
Splash guard (high risk)	Protects the detector from liquids. Impact on reading: none. Impact on response time: response time may increase for certain gases; contact us for more information.		6329014 ⚠ Plastic material. Risk of electrostatic charges. Wipe with a damp cloth

OLCT 20

GAS DETECTOR
USER MANUAL

Accessory	Use	Illustration	Code
Remote gas injection head	Used to detect ambient gases while a calibration gas injection pipe is being used. Only for combustible gases, Impact on reading: none. Impact on response time: negligible.		6327911 ⚠ Plastic material. Risk of electrostatic charges. Wipe with a damp cloth
Removable PTFE protection filter	Protects the gas inlet from liquids and dust. Impact on reading: none, but this part cannot be used for the detection of O ₃ , HCL, HF and Cl ₂ . Impact on response time: response time may increase for certain gases; contact us for more information.		6335975 ⚠ Plastic material. Risk of electrostatic charges. Wipe with a damp cloth

8 Technical Specifications

8.1 Common

Ingress Protection	IP66
Weight	800 g
Dimensions	60 X 120 mm
Source mode current	4-20 mA
Max. current	25 mA
Fault current	<1 mA

8.2 OLC 20d

Power supply:	voltage on detector terminals = 2.8 V max
Power consumption:	3-wire version = 400 mA max
Measurement signal:	Wheatstone bridge
Line length (shielded cable):	3-wire version = 1 km with 3x1.5 mm ² (32 ohms in loop mode)
Output signal	mV bridge output, 3 wires

8.3 OLCT 20d

Power supply:	voltage on detector terminals = 15 Vdc to 30 Vdc
Power consumption:	3-wire version = 100 mA 2-wire version = 25 mA
Load resistance:	maximum resistance = 250 ohms
Line length (shielded cable):	3-wire version = 1 km as 3x 1.5 mm ² (32 ohms in loop mode) 2-wire version = 4 km as 3x 1.5 mm ² (32 ohms in loop mode)

8.4 OLCT 20i

Zener barrier:	28 Vdc max - 300 ohms
Supply voltage for barrier:	19 Vdc to 26 Vdc
Voltage on detector terminals:	10 Vdc to 26 Vdc
Power consumption:	25 mA max
Load resistance:	47 ohms
Line length (shielded cable):	1 km as 3x 1.5 mm ² (32 ohms in loop mode)

8.5 Sensors

Gas type		Measure- ment range (ppm)	Explosion- proof sensor	Intrinsically- safe sensor	Temp. range (°C)	% RH	Accuracy (ppm)	Average service life	Resp. time T50/T90 (s)	Storage conditions and time
Combustible gases	Catalytic	0-100% LEL	■		-20 to +55	0-95	+/- 1% LEL (from 0-70% LEL)	40	6/15 (CH4)	(b)
AsH ₃	Arsine	1.00		■	-20 to +40	20 - 90	+/- 0.05	18	30/120	(a)
Cl ₂	Chlorine	10.0		■	-20 to +40	10 - 90	+/- 0.4	24	10/60	(a)
ClO ₂	Chlorine dioxide	3.00		■	-20 to +40	10 - 90	+/- 0.3	24	20/120	(a)
CO	Carbon monoxide	100 300 1000	■ ■ ■	■ ■ ■	-20 to +50	15 - 90	+/- 3 (0-100 range)	40	15/40	(a)
CO ₂	Carbon dioxide	0-5% vol.	■		-25 to +55	0 - 95	+/- 3%	48	11/30	(a)
COCl ₂	Phosgene	1.00		■	-20 to +40	15 - 90	+/- 0.05	12	60/180	(c)
ETO	Ethylene oxide	30.0		■	-20 to +50	15 - 90	+/- 1.0	36	50/240	(a)
H ₂	Hydrogen	2000	■	■	-20 to +50	15 - 90	+/- 5%	24	30/50	(a)
H ₂ S	Hydrogen sulfide	30.0 100 1000	■ ■ ■	■ ■ ■	-20 to +50	15 - 90	+/- 1.5 (0-30 range)	36	15/30	(a)
HCl	Hydrogen chloride	30.0 100		■	-20 to +40	15-95	+/- 0.4 (0-30 range)	24	30/150	(a)
HCN	Hydrogen cyanide	10.0 30.0		■	-20 to +40	15-95	+/- 0.3 (0-10 range)	18	30/120	(c)
HF	Hydrogen fluoride	10.0		■	-10 to +30	20 - 80	+/- 5%	12	40/90	(c)
NH ₃	Ammonia	100 1000 5000	■ ■ ■	■ ■ ■	-20 to +40	15 - 90	+/- 5 +/- 20 +/- 150 or 10%	24	25/70 20/60 60/180	(a)
NO	Nitric oxide	100 300 1000	■ ■ ■	■ ■ ■	-20 to +50	15 - 90	+/- 2 (0-100 range)	36	10/30	(a)
NO ₂	Nitrogen dioxide	10.0 30.0			-20 to +50	15-90	+/- 0.8	24	30/60	(a)
O ₂	Oxygen	0-30% vol.	■ ■	■	-20 to +50	15 - 90	0.4% vol. (from 15-22% O ₂) +/- 2%	28 60	6/15 15/25	(a)
O ₃	Ozone	1.00		■	0 to +40	10 - 90	+/- 0.03 (from 0-0.2 ppm) +/- 0.05 (from 0.2-1 ppm)	18	40/120	(c)
PH ₃	Phosphine	1.00		■	-20 to +40	20 - 90	+/- 0.05	18	30/120	(a)
SiH ₄	Silane	50.0		■	-20 to +40	20 - 95	+/- 1.0	18	25/120	(a)
SO ₂	Sulfur dioxide	10.0 30.0 100		■ ■ ■	-20 to +50	15 - 90	+/- 0.7 (0-10 range)	36	15/45	(a)
CH ₃ Cl	Chloro- methane	500	■		-20 to +55	20 - 95	+/- 15% (from 20-70% PE)	40	25/90	(d)
CH ₂ Cl ₂	Dichloro- methane	500	■		-20 to +55	20 - 95	+/- 15% (from 20-70% PE)	40	25/90	(d)
Freon R12		1% vol.	■		-20 to +55	20 - 95	+/- 15% (from 20-70% PE)	40	25/90	(d)
Freon R22		2000	■		-20 to +55	20 - 95	+/- 15% (from 20-70% PE)	40	25/90	(d)
Freon R123		2000	■		-20 to +55	20 - 95	+/- 15% (from 20-70% PE)	40	25/90	(d)
FX56		2000	■		-20 to +55	20 - 95	+/- 15% (from 20-70% PE)	40	25/90	(d)
Freon R134a		2000	■		-20 to +55	20 - 95	+/- 15% (from 20-70% PE)	40	25/90	(d)
Freon R11		1% vol.	■		-20 to +55	20 - 95	+/- 15% (from 20-70% PE)	40	25/90	(d)
Freon R23		1% vol.	■		-20 to +55	20 - 95	+/- 15% (from 20-70% PE)	40	25/90	(d)
Freon R143a		2000	■		-20 to +55	20 - 95	+/- 15% (from 20-70% PE)	40	25/90	(d)
Freon R404a		2000	■		-20 to +55	20 - 95	+/- 15% (from 20-70% PE)	40	25/90	(d)
Freon R507		2000	■		-20 to +55	20 - 95	+/- 15% (from 20-70% PE)	40	25/90	(d)
Freon R410a		1000	■		-20 to +55	20 - 95	+/- 15% (from 20-70% PE)	40	25/90	(d)
Freon R32		1000	■		-20 to +55	20 - 95	+/- 15% (from 20-70% PE)	40	25/90	(d)
Freon R407c		1000	■		-20 to +55	20 - 95	+/- 15% (from 20-70% PE)	40	25/90	(d)

Gas type	Measurement range (mm)	Explosion-proof sensor	Intrinsically-safe sensor	Temp. range (°C)	% RH	Accuracy (ppm)	Average service life	Resp. time T50/T90 (s)	Storage conditions and time
Freon R408a	1000	■		-20 to +55	20 - 95	+/- 15% (from 20-70% PE)	40	25/90	(d)
Ethanol	500	■		-20 to +55	20 - 95	+/- 15% (from 20-70% PE)	40	25/60	(d)
Toluene	500	■		-20 to +55	20 - 95	+/- 15% (from 20-70% PE)	40	25/60	(d)
Isopropanol	500	■		-20 to +55	20 - 95	+/- 15% (from 20-70% PE)	40	25/60	(d)
2-butanone (MEK)	500	■		-20 to +55	20 - 95	+/- 15% (from 20-70% PE)	40	25/60	(d)
Xylene	500	■		-20 to +55	20 - 95	+/- 15% (from 20-70% PE)	40	25/60	(d)

(a) +4°C to +20°C
20% to 60% RH
1 bar ± 10%
6 months maximum

(b) -25°C to +60°C
20% to 60% RH
1 bar ± 10%
6 months maximum

(c) +4°C to +20°C
20% to 60% RH
1 bar ± 10%
3 months maximum

(d) -20°C to +50°C
20% to 60% RH
1 bar ± 10%
6 months maximum

8.6 Cross gas factors for combustible gases

It is recommended that the detector is calibrated using the gas to be measured. Users wishing to calibrate the detector using a gas other than detected and factory-programmed should refer to the following table, and use the recommended gas and corresponding coefficient.

8.6.1 Poison resistant catalytic sensor, type 4F

Gas	Methane	Pentane	Hydrogen
Acetone	2.24	1.03	
Acetylene	1.91		
Ammonia	0.79	0.36	
Benzene	2.45	1.13	
n-Butane	2.16	0.99	
Ethane	1.47	0.78	
Ethanol	1.37	0.63	
Ethylene	1.41	0.65	
n-Hexane	2.85	1.14	
Hydrogen			1.0
Isopropanol	1.84	0.85	
JP-4	3.28	1.51	
JP-5	3.33	1.53	
JP-8	3.48	1.6	
Methane	1.0		
Methanol	1.27	0.58	
n-Pentane	2.17	1.0	
Propane	1.9	0.87	
Styrene	2.13	0.98	
Toluene	2.26	1.04	
Xylene	2.8	1.29	

Items in gray: recommended gas for calibrating the detector.

8.6.2 Poison resistant catalytic sensor, type VQ1

Gas	Chemical Formula	LEL (%)	LSE (%)	Flash point (°C)	Vapor density	Coefficient- Calibration gas CH4 (methane)	Coefficient- Calibration gas H2 (Hydrogen)	Coefficient - Calibration gas C4H10 (Butane)	Coefficient - Calibration gas C5H12 (Pentane)
Ethyl acetate	C4H8O2	2.10	11.50	-4	3.0	1.65		0.90	0.80
Acetone	C3H6O	2.15	13.00	-18	2.1	1.65		0.90	0.80
Acetylene	C2H2	2.30	100	-18	0.9	2.35	1.90	1.25	1.15
Acrylic acid	C3H4O2	2.40	8.00	54	2.5	5.00		2.65	2.40
Butyl acrylate	C7H12O2	1.20	8.00	37	4.4	3.50		1.85	1.70
Ethyl acrylate	C5H8O2	1.70	13.00	-2	3.5	3.05		1.65	1.50
Acrylonitrile	C3H3N	2.80	28.00	-1	1.8	1.45	1.20	0.80	0.70
Ammoniac	NH3	15.00	30.20	<-100	0.6	0.90	0.75	0.50	0.45
Benzene	C6H6	1.20	8.00	-11	2.7	4.00		2.15	1.90
1.3-Butadiene	C4H6	1.40	16.30	-85	1.9	2.55		1.35	1.25
Butane	C4H10	1.50	8.50	-60	2.0	1.90		1.00	0.90
Butanol (Butyl Alcohol)	C4H10O	1.4	11.3	29	2.6	1.95		1.05	0.95
2 - Butanone (MEK)	C4H8O	1.80	11.50	-4	2.5	3.90		2.10	1.90
Cyclohexane	C6H12	1.20	8.30	-17	2.9	2.00		1.10	1.00
Dimethylether	C2H6O	3.00	27.00	-41	1.6	1.80		0.95	0.90
Dodecane	C12H26	0.60	~6.0	74	5.9	4.00		2.15	1.90
Ethane	C2H6	3.00	15.50	135	1.0	1.50		0.80	0.75
Ethanol	C2H6O	3.30	19.00	13	1.6	2.15	1.75	1.15	1.05
Ether (Diethylether)	(C2H5)2O	1.70	36.00	-45	2.6	1.90		1.00	0.90
Ethylene	C2H4	2.70	34.00	-135	1.0	1.65	1.35	0.90	0.80
LPG	Prop+But	1.65	~9.0	<-50	1.9	1.90		1.00	0.90
Diesel	Melange	0.60	~6.0	55	>4	3.20		1.70	1.55
Natural Gas	CH4	5.00	15.00	-188	0.6	1.05			
HFO-1234yf		6.2	12.3			1.35		0.75	
Heptane	C7H16	1.10	6.70	-4	3.5	2.20		1.20	1.05
Hexane	C6H14	1.20	7.40	-23	3.0	2.10		1.15	1.00
Hydrogen	H2	4.00	75.60	-	0.069		1.00		
Isobutane	C4H10	1.50	8.40	-83	2.0	1.50		0.80	0.75
Isobutene	C4H8	1.60	10.00	<-10	1.9	2.20		1.20	1.05
Isopropanol	C3H8O	2.15	13.50	11.7	2.1	1.60		0.85	0.80
Kerosene (JP4)	C10 - C16	0.70	5.00	> 50	> 4	5.00		2.65	2.40
Methyl	C5H8O2	2.10	12.50	2	3.5	2.25		1.20	1.10

Gas	Chemical Formula	LEL (%)	LSE (%)	Flash point (°C)	Vapor density	Coefficient- Calibration gas CH4 (methane)	Coefficient- Calibration gas H2 (Hydrogen)	Coefficient - Calibration gas C4H10 (Butane)	Coefficient - Calibration gas C5H12 (Pentane)
Methacrylate									
Methane	CH4	5.00	15.00	-188	0.55	1.00			
Methanol	CH3OH	5.50	44.00	11	1.1	1.40	1.15	0.75	0.70
Naphta	melange (Mixture)	0.90	5.90	> 44	> 4	3.50		1.85	1.70
Nonane	C9H20	0.70	5.60	31	4.4	4.40		2.35	2.10
Octane	C8H18	1.00	6.00	12	3.9	2.70		1.45	1.30
Ethylene Oxyde	C2H4O	2.60	100	-20	1.5	2.10	1.70	1.15	1.00
Propylene oxide	C3H6O	1.90	37.00	70	2.0	2.35	1.90	1.25	1.15
Pentane	C5H12	1.40	8.00	-49	2.5	2.10		1.15	1.00
Propane	C3H8	2.00	9.5	-104	1.6	1.55		0.85	0.75
Propylene	C3H6	2.00	11.70	-107.8	1.5	1.65		0.90	0.80
Styrene	C8H8	1.1	8.00	31	3.6	6.30		3.35	3.00
Gasoline lead free	/	1.10	~6.0	21	3 à 4	1.80		0.95	0.90
Toluene	C7H8	1.20	7	5	3.1	4.00		2.15	1.90
Turpentine Oil	-	0.8	6.0	35	4.7	3.50		1.85	1.70
Triethyl amine	C6H15N	1.20	8	-15	3.5	2.05		1.10	1.00
White Spirit	melange (Mixture)	1.10	6.50	>30	> 4	3.50		1.85	1.70
Xylene	C8H10	1.00	7.60	25	3.7	4.00		2.15	1.90

Items in gray: recommended gas for calibrating the detector.

Example

Calibration of an "acetone" detector using a calibration gas with 1% butane
Value to be displayed:

$$\frac{1\% \text{ (injected butane)}}{1.5\% \text{ (butane LEL)}} \times 100 \times 0.90 \text{ (butane/acetone coefficient)} = 60\% \text{ LEL}$$

Note:

- LELs vary according to the source.
- Coefficients are accurate to $\pm 15\%$.

9 Special instructions for use in explosive atmospheres and functional safety

9.1 General comments

OLCT 20 gas detectors comply with the requirements of ATEX 2014/34/UE European Directive relating to explosive Dust and Gas atmospheres.

The information given in the following sections should be respected and taken into account by the manager of the site where the equipment is installed. With respect to requirements for improving the safety and health protection of workers potentially at risk from explosive atmospheres, please refer to ATEX 1999/92/CE European Directive.

9.2 Warnings

Do not open when energized. After de-energizing, delay 2 minutes before opening. Read instructions notice (cable glands).

9.3 Requirements for use in dust explosive atmospheres

For the equipment installed in dust explosive atmosphere, user shall ensure a sufficient cleaning to prevent dust accumulation on the device. The maximum permissible thickness of a dust layer must be less than 5 mm.

9.4 Cable entries

Cable glands and other wiring accessories (plugs, adaptors, etc.) shall be "db" certified for use in gas explosive atmospheres and "tb" for use in dust explosive atmospheres. They must be at least IP66 and of M20x1.5 6g or M25x1.5 6g types in accordance with ISO965-1 and ISO965-3 standards. Minimum depth of engagement must be 5 threads and installation must be done in accordance with current version of EN 60079-14 and eventually with any local or national additional requirements that may apply in the country of installation.

The cables should be suitable for use at a temperature equal to or greater than 80°C.

9.5 Threaded joints

Threaded joints have different values than those specified in EN60079-1 standard. TELEDYNE OLDHAM SIMTRONICS does not allow the repair of the threaded joints and shall not be held responsible for any damage to the equipment or for any physical injury or death resulting from any product modification.

The threaded joints on the *OLCT 20* may be lubricated to ensure protection against explosions. Only non-hardening lubricants or non-corrosive agents without volatile solvents may be used. Warning: silicone-based lubricants are strictly prohibited since they contaminate some of the gas sensing elements used in the *OLCT 20*.

9.6 Limitations of use

Gas detection cells have certain limitations that shall be known and understood by the user.

9.7 Overrange and exposition to specific components

- A bump test and/or a calibration is recommended each time the detector has been exposed to high gas concentration and moreover if the detector went to overrange condition.
- Vapors from silicone or sulfur compounds can affect the catalytic sensor and thereby distort the measurements. If the sensors have been exposed to these types of compounds, an inspection or calibration must be performed.
- High concentration of organic solvents (e.g. alcohols, aromatic solvents, etc.) or exposure to gas concentration above the measuring range can damage electrochemical sensors. If sensors have been exposed to such condition, a bump test or calibration must be then performed.
- In the event of high levels of Carbon Dioxide ($\text{CO}_2 > 1\% \text{ vol.}$), electrochemical Oxygen (O_2) sensors can slightly overestimate the actual concentration of oxygen by 0.1 to 0.5% volume.

9.8 Operation under low oxygen levels

- If an electrochemical detector sensor is used in an atmosphere comprising less than 1% oxygen for over one hour, the measurement may be an underestimate.
- If a thermocatalytic detector sensor is used in an atmosphere comprising less than 10% oxygen, the measurement may be an underestimate.
- If a semiconductor detector sensor is used in an atmosphere comprising less than 18% oxygen, the measurement may be an underestimate.

9.9 Installation and calibration

- The detector will be installed with the sensor cell pointing downwards
- The detector should be calibrated with the gas to be measured. With respect to combustible gases only, and in the event it is impossible to calibrate with the targeted gas, see tables on pages 22 and further for recommended calibration gas and cross gas interference.
- Transfer curve for OLCT20 gas detectors

The curve below gives the transmitter output current as a function of gas concentration. In the event that the user connects the transmitter to a non-TELEDYNE OLDHAM SIMTRONICS central controller, the user must ensure that the transfer curve is compatible with the equipment's input characteristics to correctly interpret the data coming in from the transmitter. Similarly, the central controller must provide sufficient voltage to compensate for any voltage drop caused by the cable.

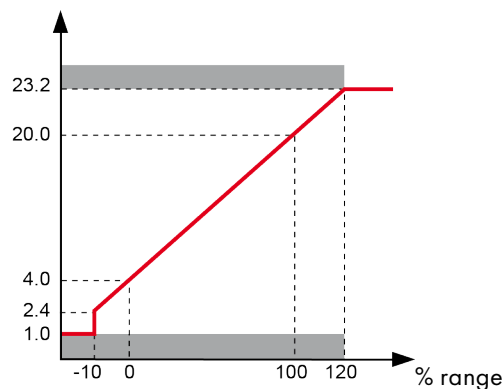

9.10 Marking

Safety relevant parameters:

OLC 20d and OLC 20d HT

- Maximum supply voltage: 2,8 Vdc
- Maximum supply current: 400 mA
- Maximum power: 0,8 W

OLCT 20d

- Maximum input voltage: 30 Vdc
- Maximum input current: 100 mA

OLCT 20i

Ui (V)	Ii (mA)	Pi (mW)	Ci (nF)	Li (μH)
28	94	658	46	15

OLCT 20

GAS DETECTOR
USER MANUAL

OLC 20d detector

TELEDYNE OLDHAM SIMTRONICS SAS

62027, ARRAS France

OLC20d

CE0080

INERIS 01ATEX0004X

 II 2 GD

Ex db IIC T6 Gb

Ex tb IIIC T85°C Db

T.Amb : -20°C to 70°C

WARNING: Do not open when energized. Read user manual (cable entry).

OLC 20d HT detector

TELEDYNE OLDHAM SIMTRONICS SAS

62027, ARRAS France

OLC20d HT

CE0080

INERIS 01ATEX0004X

 II 2 GD

Ex db IIC T* Gb

Ex tb IIIC T* Db

T.Amb : -20°C to T* °C

(*)T4 for T_{amb} up to +110°C, T3 for T_{amb} up to +180°C, T2 for T_{amb} up to 200°C

WARNING: Do not open when energized. Read user manual (cable glands).

OLCT 20d detector

TELEDYNE OLDHAM SIMTRONICS SAS

62027, ARRAS France

OLCT20d

CE0080

INERIS 01ATEX0004X

 II 2 GD

Ex db IIC T6 Gb

Ex tb IIIC T85°C Db

T.Amb : -20°C to 70°C

WARNING: Do not open when energized. Read user manual (cable entry).

OLCT 20i detector

TELEDYNE OLDHAM SIMTRONICS SAS

62027, ARRAS France

OLCT20i

CE0080

INERIS 01ATEX0004X

 II 1 GD

Ex ia IIC T4 Ga

Ex ia IIIC T135°C Da

T.Amb : -20°C to 70°C





TELEDYNE
OLDHAM SIMTRONICS
Everywhereyoulook™



AMERICAS

14880 Skinner Rd
CYPRESS
TX 77429,
USA
Tel.: +1-713-559-9200

EMEA

Rue Orfila
Z.I. Est – CS 20417
62027 ARRAS Cedex,
FRANCE
Tel.: +33 (0)3 21 60 80 80

ASIA PACIFIC

Room 04, 9th Floor, 275
Ruiping Road, Xuhui District
SHANGHAI
CHINA
TGFD_APAC@Teledyne.com

www.teledynegasandflamedetection.com



© 2024 TELEDYNE OLDHAM SIMTRONICS. All right reserved.

NPO20GB Revision H.0 / February 2024